

# AMMETER TRANSFER SWITCHES

## 3-PHASE, 2 CURRENT TRANSFORMERS - 2407C

Handle: Round Knurled  
 Jumpers supplied as shown  
 Engraving Code: 010C-3A10A

DECKS	CONTACTS	POSITIONS		
		1 *	2 *	3
1	11			
	13	X	X	X
2	21			
	23		X	X

\* Denotes make-before-break

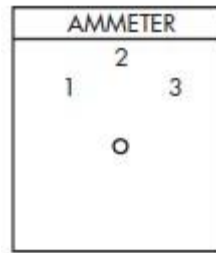
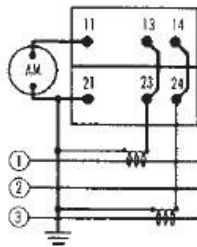

## 3-PHASE, 2 CURRENT TRANSFORMERS - 2408C

Handle: Round Knurled  
 Jumpers supplied as shown  
 Engraving Code: 010C-4A13

DECKS	CONTACTS	POSITIONS			
		OFF	1 *	2 *	3
1	11				
	13		X	X	X
2	21				
	23		X	X	X

\* Denotes make-before-break

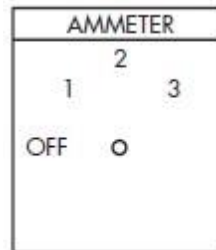
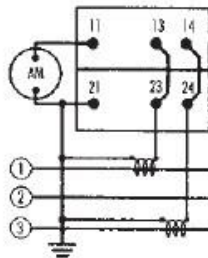

## 3-PHASE, 3 CURRENT TRANSFORMERS - 2410C

Handle: Round Knurled  
 Jumpers supplied as shown  
 Engraving Code: 010C-4A13

DECKS	CONTACTS	POSITIONS			
		OFF	1 *	2 *	3
1	11				
	12		X	X	X
	13		X	X	X
2	21				
	22		X	X	X
	23		X	X	X

\* Denotes make-before-break

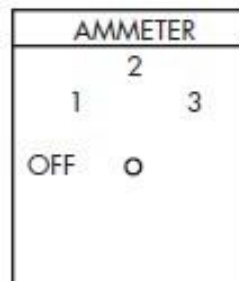
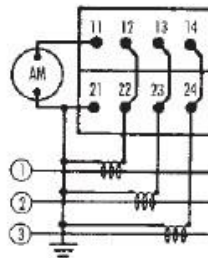

### 3-PHASE, 3 CURRENT TRANSFORMERS - 2411C

#### THREE INDEPENDENT CIRCUITS

Handle: Round Knurled

Jumpers supplied as shown

Engraving Code: 010C-3A10

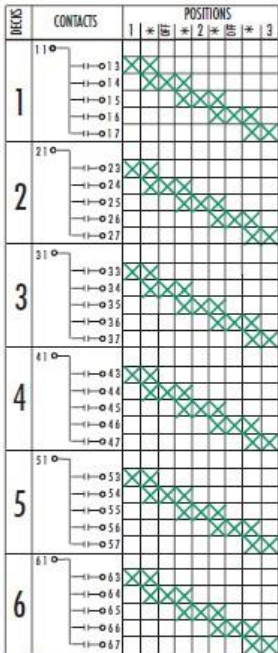

\* Denotes make-before-break

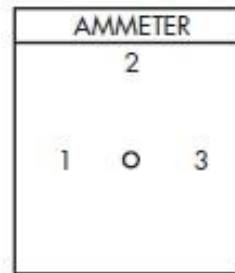
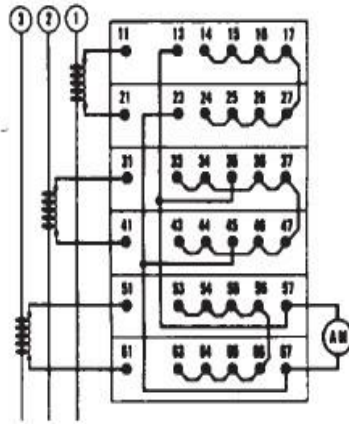

### 3-PHASE, 3 CURRENT TRANSFORMERS - 2412C

#### 3 INDEPENDENT CIRCUITS

Handle: Round Knurled

Jumpers supplied as shown

Engraving Code: 010C-5A16

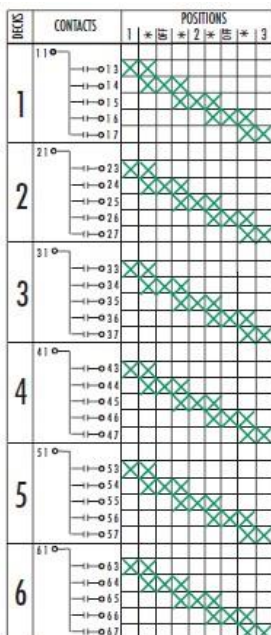

\* Denotes make-before-break

